

Building Bayes Networks: Structure Learning

Evaluation Measures and Search Methods

A learning algorithm for graphical models consists of an evaluation measure, by which a candidate model is assessed and a (heuristics) search method, which determines the candidate models to be inspected.

An exhaustive search over all graphs is too expensive:

- $2^{\binom{n}{2}}$ possible undirected graphs for n attributes.
- $f(n) = \sum_{i=1}^n (-1)^{i+1} \binom{n}{i} 2^{i(n-i)} f(n-i)$ possible directed acyclic graphs.

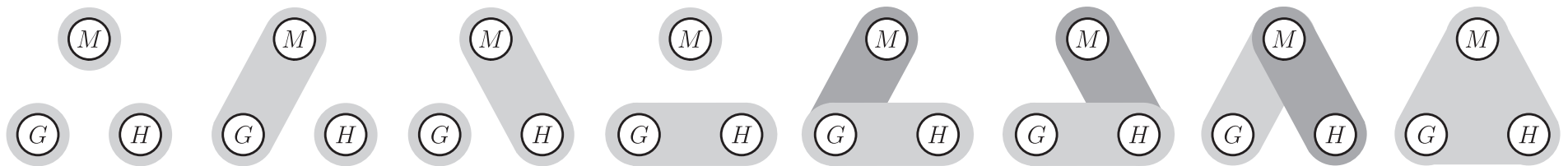

8 possible undirected graphs with 3 nodes

Evaluation Measures for Relational Networks

Hartley Information Gain

Conditional Hartley Information Gain

Evaluation Measures for Probabilistic Networks

χ^2 -Measure

Mutual Information / Cross Entropy / Information Gain

(Symmetric/Modified) Gini Index

Bayesian Measures (K2 metric, BDeu metric)

Measures based on the Minimum Description Length Principle

Other measures that are known from Decision Tree Induction

Search Methods

Optimum weight spanning tree construction (extension: K2 Algorithm)

Guided random graph search (simulated annealing, evolutionary algorithms)

Learning the Structure of Graphical Models from Data

(A) Test whether a distribution is decomposable w. r. t. a given graph.

This is the most direct approach. It is not bound to a graphical representation, but can also be carried out w.r.t. other representations of the set of subspaces to be used to compute the (candidate) decomposition of the given distribution.

(B) Find a suitable graph by measuring the strength of dependences.

This is a heuristic, but often highly successful approach, which is based on the frequently valid assumption that in a conditional independence graph an attribute is more strongly dependent on adjacent attributes than on attributes that are not directly connected to them.

(C) Find an independence map by conditional independence tests.

This approach exploits the theorems that connect conditional independence graphs and graphs that represent decompositions. It has the advantage that a single conditional independence test, if it fails, can exclude several candidate graphs. However, wrong test results can thus have severe consequences.

Testing for Decomposability: Comparing Relations

In order to evaluate a graph structure, we need a measure that compares the actual relation to the relation represented by the graph.

For arbitrary R , E_1 , and E_2 it is

$$R(E_1 \cap E_2) \leq \min\{R(E_1), R(E_2)\}.$$

This relation entails that for any family \mathcal{M} of subsets of U it is always:

$$\forall a_1 \in \text{dom}(A_1) : \dots \forall a_n \in \text{dom}(A_n) : \\ r_U \left(\bigwedge_{A_i \in U} A_i = a_i \right) \leq \min_{M \in \mathcal{M}} \left\{ r_M \left(\bigwedge_{A_i \in M} A_i = a_i \right) \right\}.$$

Therefore: Measure the quality of a family \mathcal{M} as:

$$\sum_{a_1 \in \text{dom}(A_1)} \dots \sum_{a_n \in \text{dom}(A_n)} \left(\min_{M \in \mathcal{M}} \left\{ r_M \left(\bigwedge_{A_i \in M} A_i = a_i \right) \right\} - r_U \left(\bigwedge_{A_i \in U} A_i = a_i \right) \right)$$

Intuitively: **Count the number of additional tuples.**

Direct Test for Decomposability: Relational

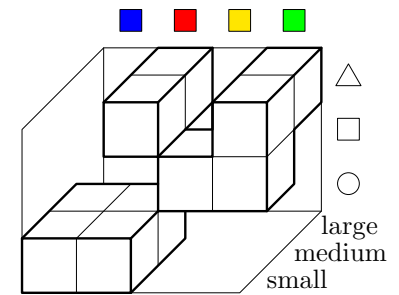
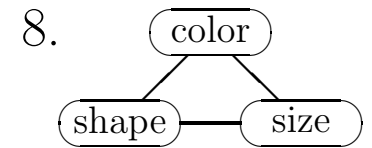
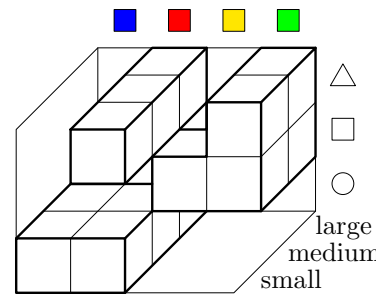
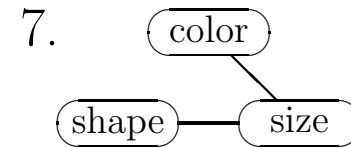
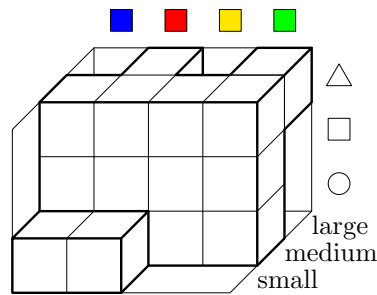
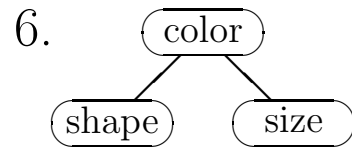
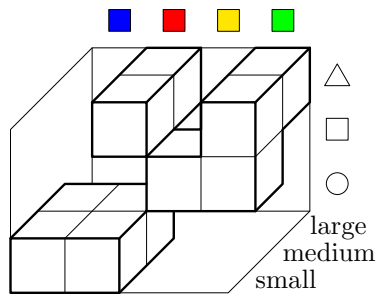
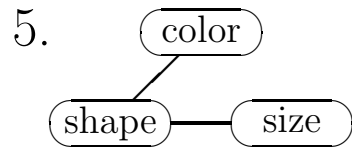
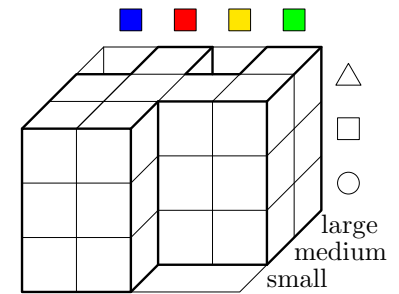
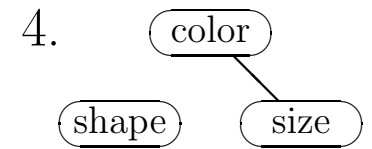
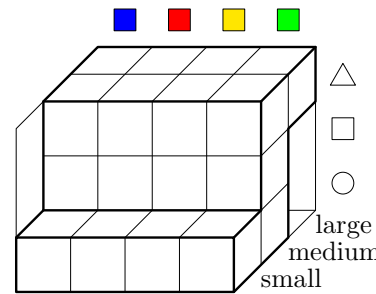
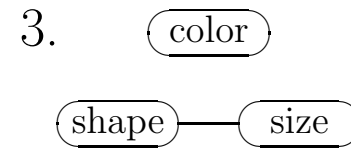
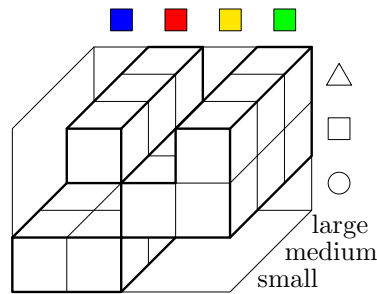
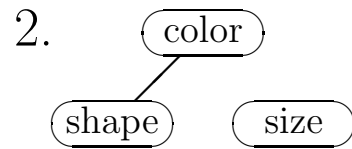
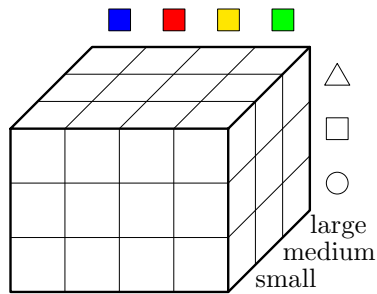
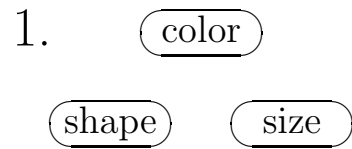

Comparing Probability Distributions

Definition: Let P_1 and P_2 be two strictly positive probability distributions on the same set \mathcal{E} of events. Then

$$I_{\text{KLdiv}}(P_1, P_2) = \sum_{F \in \mathcal{E}} P_1(F) \log_2 \frac{P_1(F)}{P_2(F)}$$

is called the **Kullback-Leibler information divergence** of P_1 and P_2 .

The Kullback-Leibler information divergence is non-negative.

It is zero if and only if $P_1 \equiv P_2$.

Therefore it is plausible that this measure can be used to assess the quality of the approximation of a given multi-dimensional distribution P_1 by the distribution P_2 that is represented by a given graph:

The smaller the value of this measure, the better the approximation.

Extensions to Probability Distribution

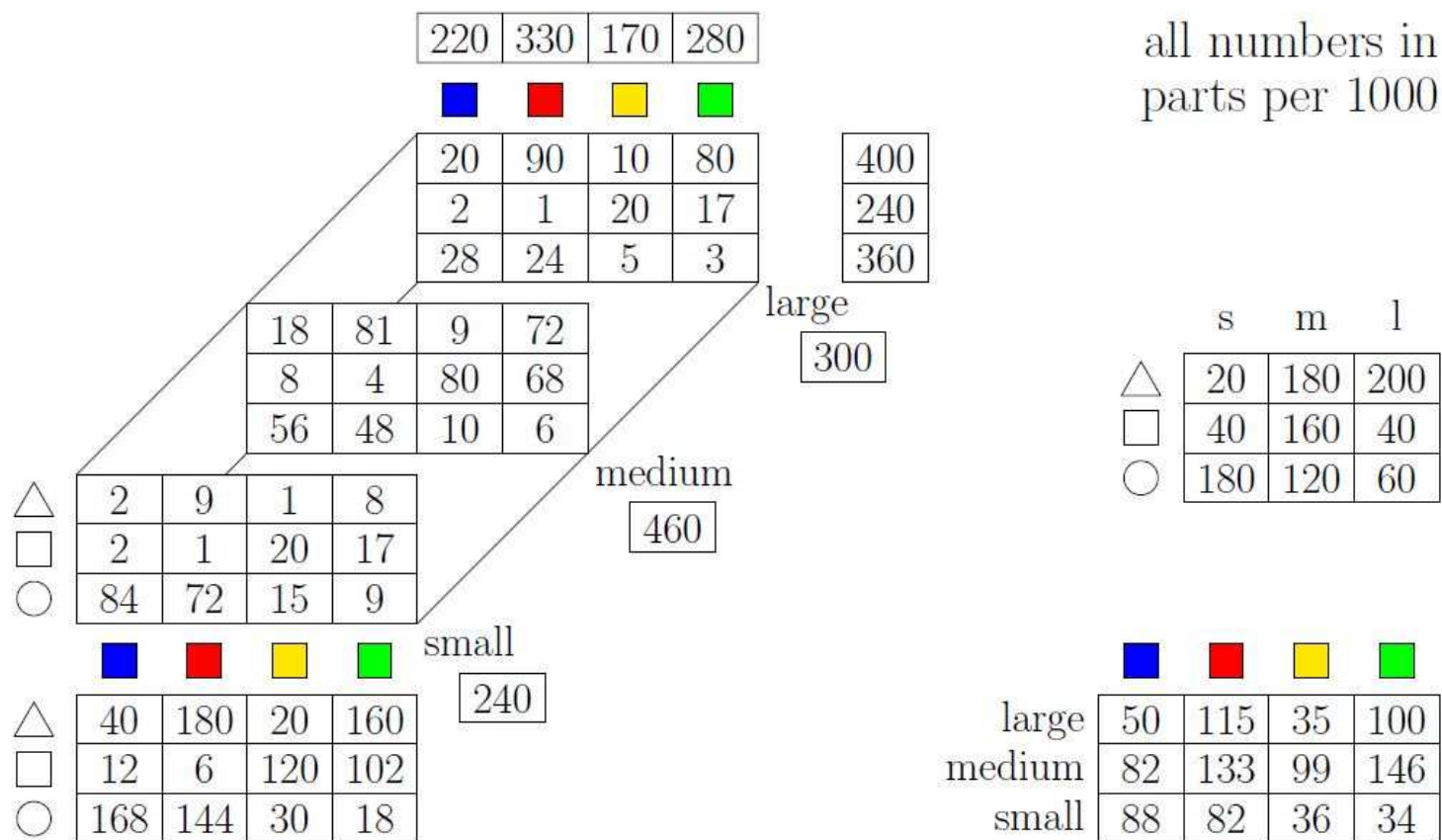

The numbers state the probability of the corresponding value combination. Compared to the example relation, the possible combinations are now frequent.

Direct Test for Decomposability: Probabilistic

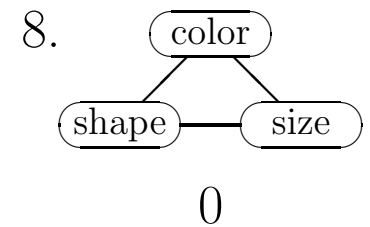
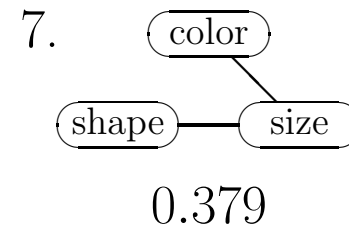
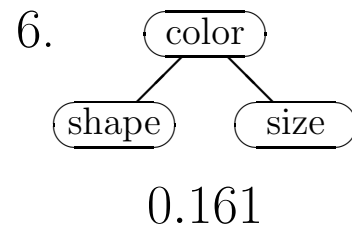
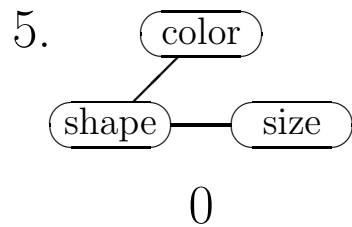
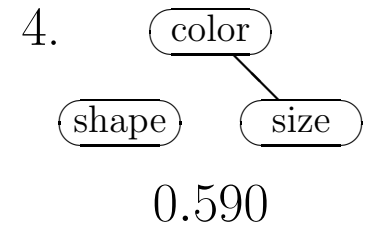
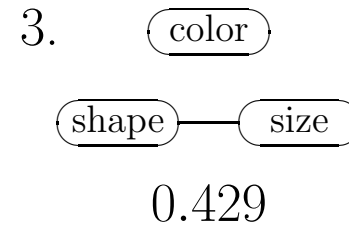
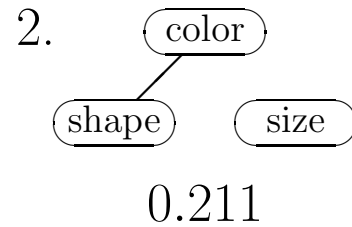
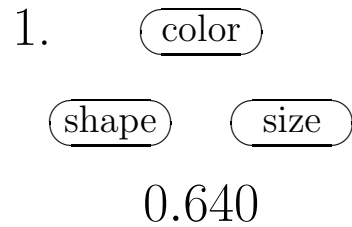

Numbers below graphs: The Kullback-Leibler information divergence of the original distribution and its approximation.

Learning the Structure of Graphical Models from Data

(A) Test whether a distribution is decomposable w.r.t. a given graph.

This is the most direct approach. It is not bound to a graphical representation, but can also be carried out w.r.t. other representations of the set of subspaces to be used to compute the (candidate) decomposition of the given distribution.

(B) Find a suitable graph by measuring the strength of dependences.

This is a heuristic, but often highly successful approach, which is based on the frequently valid assumption that in a conditional independence graph an attribute is more strongly dependent on adjacent attributes than on attributes that are not directly connected to them.

(C) Find an independence map by conditional independence tests.

This approach exploits the theorems that connect conditional independence graphs and graphs that represent decompositions. It has the advantage that a single conditional independence test, if it fails, can exclude several candidate graphs. However, wrong test results can thus have severe consequences.

Strength of Marginal Dependences: Relational

Learning a relational network consists in finding those subspace, for which the intersection of the cylindrical extensions of the projections to these subspaces approximates best the set of possible world states, i. e. contains as few additional tuples as possible.

Since computing explicitly the intersection of the cylindrical extensions of the projections and comparing it to the original relation is too expensive, local evaluation functions are used, for instance:

subspace	color \times shape	shape \times size	size \times color
possible combinations	12	9	12
occurring combinations	6	5	8
relative number	50%	56%	67%

The relational network can be obtained by interpreting the relative numbers as edge weights and constructing the minimum weight spanning tree.

Strength of Marginal Dependences: Relational

Definition: Let A be an attribute and R a discrete possibility measure with $\exists a \in \text{dom}(A) : R(A = a) = 1$. Then

$$(\text{Hartley})(A) = \log_2 \left(\sum_{a \in \text{dom}(A)} R(A = a) \right)$$

is called the **Hartley information** of A w.r.t. R .

	■		■
		■	■
■	■		

Hartley information needed to determine

coordinates: $\log_2 4 + \log_2 3 = \log_2 12 \approx 3.58$

coordinate pair: $\log_2 6 \approx 2.58$

Strength of Marginal Dependences: Relational

Definition: Let A and B be two attributes and R a discrete possibility measure with $\exists a \in \text{dom}(A) : \exists b \in \text{dom}(B) : R(A = a, B = b) = 1$. Then

$$\begin{aligned} I_{\text{gain}}^{(\text{Hartley})}(A, B) &= \log_2 \left(\sum_{a \in \text{dom}(A)} R(A = a) \right) + \log_2 \left(\sum_{b \in \text{dom}(B)} R(B = b) \right) \\ &\quad - \log_2 \left(\sum_{a \in \text{dom}(A)} \sum_{b \in \text{dom}(B)} R(A = a, B = b) \right) \\ &= \log_2 \frac{\left(\sum_{a \in \text{dom}(A)} R(A = a) \right) \cdot \left(\sum_{b \in \text{dom}(B)} R(B = b) \right)}{\sum_{a \in \text{dom}(A)} \sum_{b \in \text{dom}(B)} R(A = a, B = b)}, \end{aligned}$$

is called the **Hartley information gain** of A and B w.r.t. R .

	■		■
		■	■
■	■		

Hartley information needed to determine

coordinates: $\log_2 4 + \log_2 3 = \log_2 12 \approx 3.58$

coordinate pair: $\log_2 6 \approx 2.58$

gain: $\log_2 12 - \log_2 6 = \log_2 2 = 1$

Strength of Marginal Dependences: Simple Example

Intuitive interpretation of Hartley information gain:

The binary logarithm measures the number of questions to find the obtaining value with a scheme like a binary search. Thus Hartley information gain measures the reduction in the number of necessary questions.

Results for the simple example:

$$I_{\text{gain}}^{(\text{Hartley})}(\text{color, shape}) = 1.00 \text{ bit}$$

$$I_{\text{gain}}^{(\text{Hartley})}(\text{shape, size}) \approx 0.86 \text{ bit}$$

$$I_{\text{gain}}^{(\text{Hartley})}(\text{color, size}) \approx 0.58 \text{ bit}$$

Applying the Kruskal algorithm yields as a learning result:

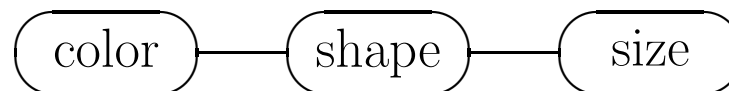

As we know, this graph describes indeed a decomposition of the relation.

Kruskal's Algorithm

Kruskal's algorithm is a greedy algorithm in graph theory, which finds a minimum spanning tree for a connected weighted graph.

A minimum spanning tree consists of a subset of edges that forms a tree which includes every vertex, where the total weight of all the edges in the tree is minimized.

Algorithm:

1. Create a graph F , where each vertex in the graph is a separate tree
2. Create a set S containing all the edges in the graph
3. While S is nonempty and F is not yet spanning:
 - (a) remove an edge with minimum weight from S
 - (b) if the removed edge connects two different trees then add it to the forest F , combining two trees into a single tree

At the termination of the algorithm, the forest forms a minimum spanning forest of the graph. If the graph is connected, the forest has a single component and forms a minimum spanning tree

Strength of Marginal Dependences: Probabilistic

Mutual Information / Cross Entropy / Information Gain

Based on Shannon Entropy $H = - \sum_{i=1}^n p_i \log_2 p_i$ (Shannon 1948)

$$\begin{aligned} I_{\text{gain}}(A, B) &= \underbrace{H(A)}_{-\sum_a P(a) \log_2 P(a)} - \underbrace{H(A | B)}_{\sum_b P(b) \left(-\sum_a P(a|b) \log_2 P(a|b) \right)} \\ &= -\sum_a P(a) \log_2 P(a) - \sum_b P(b) \left(-\sum_a P(a|b) \log_2 P(a|b) \right) \end{aligned}$$

$H(A)$ Entropy of the distribution on attribute A
 $H(A|B)$ *Expected entropy* of the distribution on attribute A
if the value of attribute B becomes known
 $H(A) - H(A|B)$ Expected reduction in entropy or *information gain*

Strength of Marginal Dependences: Probabilistic

$$\begin{aligned} I_{\text{gain}}(A, B) &= - \sum_a P(a) \log_2 P(a) - \sum_b P(b) \left(- \sum_a P(a|b) \log_2 P(a|b) \right) \\ &= - \sum_a \sum_b P(a, b) \log_2 P(a) + \sum_b \sum_a P(a|b) P(b) \log_2 P(a|b) \\ &= \sum_a \sum_b P(a, b) \left(\log_2 \frac{P(a, b)}{P(b)} - \log_2 P(a) \right) \\ &= \sum_a \sum_b P(a, b) \log_2 \frac{P(a, b)}{P(a)P(b)} \end{aligned}$$







The information gain equals the Kullback-Leibler information divergence between the actual distribution $P(A, B)$ and a hypothetical distribution P^* in which A and B are marginal independent:

$$P^*(A, B) = P(A) \cdot P(B)$$







$$I_{\text{gain}}(A, B) = I_{\text{KLdiv}}(P, P^*)$$

Information Gain: Simple Example

projection to subspace



				
	40	180	20	160
	12	6	120	102
	168	144	30	18



product of marginals

				
	88	132	68	112
	53	79	41	67
	79	119	61	101





information gain





0.429 bit

	s	m	l
	20	180	200
	40	160	40
	180	120	60

	s	m	l
	96	184	120
	58	110	72
	86	166	108

0.211 bit

				
large	50	115	35	100
medium	82	133	99	146
small	88	82	36	34

				
large	66	99	51	84
medium	101	152	78	129
small	53	79	41	67

0.050 bit

Strength of Marginal Dependences: Simple Example

Results for the simple example:

$$I_{\text{gain}}(\text{color}, \text{shape}) = 0.429 \text{ bit}$$

$$I_{\text{gain}}(\text{shape}, \text{size}) = 0.211 \text{ bit}$$

$$I_{\text{gain}}(\text{color}, \text{size}) = 0.050 \text{ bit}$$

The Kruskal algorithm is a greedy algorithm which can be used to determine the minimal spanning tree of an undirected graph.

Applying the Kruskal algorithm yields as a learning result:



It can be shown that this approach always yields the best possible spanning tree w.r.t. Kullback-Leibler information divergence (Chow and Liu 1968).

In an extended form this also holds for certain classes of graphs (for example, tree-augmented naive Bayes classifiers).

For more complex graphs, the best graph need not be found (there are counterexamples, see below).

Optimum Weight Spanning Tree Construction

- Compute an evaluation measure on all possible edges (two-dimensional subspaces).
- Use the Kruskal algorithm to determine an optimum weight spanning tree.

Greedy Parent Selection (for directed graphs)

- Define a topological order of the attributes (to restrict the search space).
- Compute an evaluation measure on all single attribute hyperedges.
- For each preceding attribute (w.r.t. the topological order):
add it as a candidate parent to the hyperedge and
compute the evaluation measure again.
- Greedily select a parent according to the evaluation measure.
- Repeat the previous two steps until no improvement results from them.

K2 Algorithm

Idea: Compute the probability of a directed graph B_S given the database D (Bayesian approach by [Cooper and Herskovits 1992])

$$\begin{aligned}\hat{B}_S &= \arg \max_{B_S} P(B_S | D) = \arg \max_{B_S} \frac{P(B_S, D)}{P(D)} \\ &= \arg \max_{B_S} P(B_S, D)\end{aligned}$$

Find an equation for $P(B_S, D)$.

Model Averaging

We first consider $P(B_S, D)$ to be the marginalization of $P(B_S, B_P, D)$ over all possible parameters B_P .

$$\begin{aligned} P(B_S, D) &= \int_{B_P} P(B_S, B_P, D) \, dB_P \\ &= \int_{B_P} P(D \mid B_S, B_P) P(B_S, B_P) \, dB_P \\ &= \int_{B_P} P(D \mid B_S, B_P) f(B_P \mid B_S) P(B_S) \, dB_P \\ &= \underbrace{P(B_S)}_{\text{A priori prob.}} \int_{B_P} \underbrace{P(D \mid B_S, B_P)}_{\text{Likelihood of } D} \underbrace{f(B_P \mid B_S)}_{\text{Parameter densities}} \, dB_P \end{aligned}$$

K2 Algorithm

The a priori distribution $P(B_S)$ can be used to bias the evaluation measure towards user-specific network structures.

Substitute the likelihood $P(D | B_S, B_P)$ for its specific form:

$$P(B_S, D) = P(B_S) \int_{B_P} \underbrace{\left[\prod_{i=1}^n \prod_{j=1}^{q_i} \prod_{k=1}^{r_i} \theta_{ijk}^{\alpha_{ijk}} \right]}_{P(D|B_S, B_P)} f(B_P | B_S) dB_P$$

See slide 354 for the derivation of the likelihood term.

K2 Algorithm

The parameter densities $f(B_P | B_S)$ describe the probabilities of the parameters given a network structure.

They are densities of second order (distribution over distributions)

For fixed i and j , a vector $(\theta_{ij1}, \dots, \theta_{ijr_i})$ represents a probability distribution, namely the j -th column of the i -th potential table.

Assuming mutual independence between the potential tables, we arrive for $f(B_P | B_S)$ at the following:

$$f(B_P | B_S) = \prod_{i=1}^n \prod_{j=1}^{q_i} f(\theta_{ij1}, \dots, \theta_{ijr_i})$$

K2 Algorithm

Thus, we can further concretize the equation for $P(B_S, D)$:

$$\begin{aligned} P(B_S, D) &= P(B_S) \int \cdots \int_{\theta_{ijk}} \left[\prod_{i=1}^n \prod_{j=1}^{q_i} \prod_{k=1}^{r_i} \theta_{ijk}^{\alpha_{ijk}} \right] \cdot \left[\prod_{i=1}^n \prod_{j=1}^{q_i} f(\theta_{ij1}, \dots, \theta_{ijr_i}) \right] d\theta_{111}, \dots, d\theta_{nq_n r_n} \\ &= P(B_S) \prod_{i=1}^n \prod_{j=1}^{q_i} \int \cdots \int_{\theta_{ijk}} \left[\prod_{k=1}^{r_i} \theta_{ijk}^{\alpha_{ijk}} \right] \cdot f(\theta_{ij1}, \dots, \theta_{ijr_i}) d\theta_{ij1}, \dots, d\theta_{ijr_i} \end{aligned}$$

K2 Algorithm

A last assumption: For fixed i and j the density $f(\theta_{ij1}, \dots, \theta_{ijr_i})$ is uniform:

$$f(\theta_{ij1}, \dots, \theta_{ijr_i}) = (r_i - 1)!$$

It simplifies $P(B_S, D)$ further:

$$\begin{aligned} P(B_S, D) &= P(B_S) \prod_{i=1}^n \prod_{j=1}^{q_i} \int \cdots \int_{\theta_{ijk}} \left[\prod_{k=1}^{r_i} \theta_{ijk}^{\alpha_{ijk}} \right] \cdot (r_i - 1)! d\theta_{ij1}, \dots, d\theta_{ijr_i} \\ &= P(B_S) \prod_{i=1}^n \prod_{j=1}^{q_i} (r_i - 1)! \underbrace{\int \cdots \int_{\theta_{ijk}} \prod_{k=1}^{r_i} \theta_{ijk}^{\alpha_{ijk}} d\theta_{ij1}, \dots, d\theta_{ijr_i}}_{\text{Dirichlet's integral}} \\ &\quad \text{Dirichlet's integral} = \frac{\prod_{k=1}^{r_i} \alpha_{ijk}!}{(\sum_{k=1}^{r_i} \alpha_{ijk} + r_i - 1)!} \end{aligned}$$

K2 Algorithm

We finally arrive at an expression for $P(B_S, D)$:

$$P(B_S, D) = \text{K2}(B_S | D) = P(B_S) \prod_{i=1}^n \prod_{j=1}^{q_i} \left[\frac{(r_i - 1)!}{(N_{ij} + r_i - 1)!} \prod_{k=1}^{r_i} \alpha_{ijk}! \right]$$

n number of attributes describing the domain under consideration

r_i number of values of the i -th attribute A_i , i. e., $r_i = |\text{dom}(A_i)|$

q_i number of instantiations of the parents of the i -th attribute in \vec{G} ,
i. e., $q_i = \prod_{A_j \in \text{parents}(A_i)} r_j = \prod_{A_j \in \text{parents}(A_i)} |\text{dom}(A_j)|$

α_{ijk} number of sample cases in which the i -th attribute has its k -th value
and its parents in \vec{G} have their j -th instantiation

$$N_{ij} = \sum_{k=1}^{r_i} \alpha_{ijk}$$

Properties of the K2 Metric

Global — Refers to the outer product: The total value of the K2 metric is the product over all K2 values of attribute families.

Local — The likelihood equation assumes that given a parents instantiation, the probabilities for the respective child attribute values are mutual independent. This is reflected in the product over all q_i different parent attributes' value combinations of attribute A_i .

We exploit the global property to write the K2 metric as follows:

$$K2(B_S | D) = P(B_S) \prod_{i=1}^n K2_{\text{local}}(A_i | D)$$

with

$$K2_{\text{local}}(A_i | D) = \prod_{j=1}^{q_i} \left[\frac{(r_i - 1)!}{(N_{ij} + r_i - 1)!} \prod_{k=1}^{r_i} \alpha_{ijk}! \right]$$

K2 Algorithm

Prerequisites:

Choose a topological order on the attributes (A_1, \dots, A_n)

Start out with a network that consists of n isolated nodes.

Let ζ_i be the quality of the i -th attribute given the (tentative) set of parent attributes M :

$$\zeta_i(M) = \text{K2}_{\text{local}}(A_i \mid D) \quad \text{with} \quad \text{parents}(A_i) = M$$

K2 Algorithm

Execution:

1. Determine for the parentless node A_i the quality measure $\zeta_i(\emptyset)$
2. Evaluate for every predecessor $\{A_1, \dots, A_{i-1}\}$ whether inserted as parent of A_i , the quality measure would increase. Let Y be the node that yields the highest quality (increase):

$$Y = \arg \max_{1 \leq l \leq i-1} \zeta_i(\{A_l\})$$

This best quality measure be $\zeta = \zeta_i(\{Y\})$.

3. If ζ is better than $\zeta_i(\emptyset)$, Y is inserted permanently as a parent node: $\text{parents}(A_i) = \text{parents}(A_i) \cup \{Y\}$
4. Repeat steps 2 and 3 to increase the parent set until no quality increase can be achieved or no nodes are left or a predefined maximum number of parent nodes per node is reached.

K2 Algorithm

```
1: for  $i \leftarrow 1 \dots n$  do // Initialization
2:    $\text{parents}(A_i) \leftarrow \emptyset$ 
3: end for
4: for  $i \leftarrow n, \dots, 1$  do // Iteration
5:   repeat
6:     Select  $Y \in \{A_1, \dots, A_{i-1}\} \setminus \text{parents}(A_i)$ ,
       which maximizes  $\zeta = \zeta_i(\text{parents}(A_i) \cup \{Y\})$ 
7:      $\delta \leftarrow \zeta - \zeta_i(\text{parents}(A_i))$ 
8:     if  $\delta > 0$  then
9:        $\text{parents}(A_i) \leftarrow \text{parents}(A_i) \cup \{Y\}$ 
10:    end if
11:  until  $\delta \leq 0$  or  $\text{parents}(A_i) = \{A_1, \dots, A_{i-1}\}$  or  $|\text{parents}(A_i)| = n_{\max}$ 
12: end for
```

Demo of K2 Algorithm

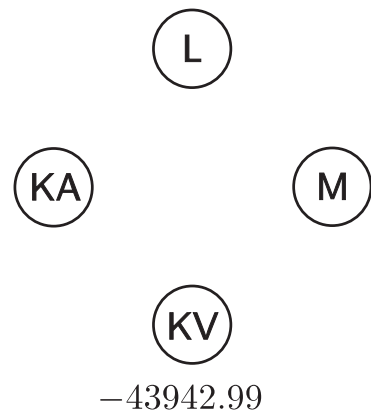

Step 1 – Edgeless graph

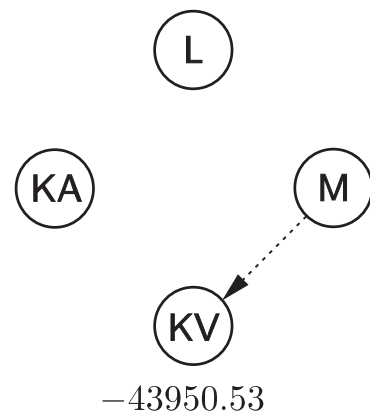

Step 2 – Insert M temporarily.

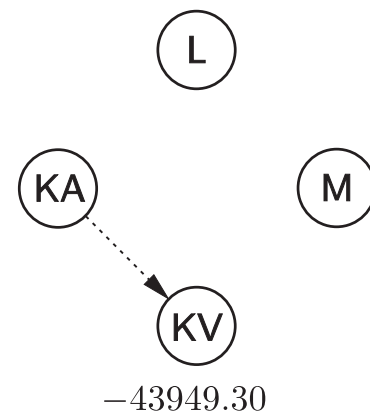

Step 3 – Insert KA temporarily.

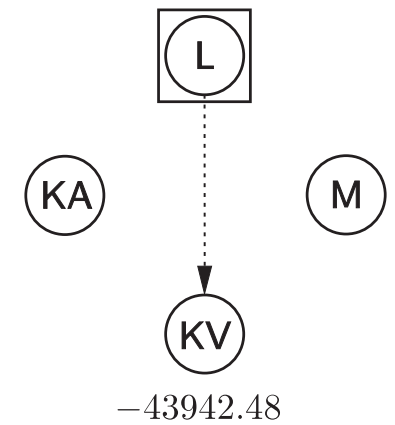

Step 4 – Node L maximizes K2 value and thus is added permanently.

Demo of K2 Algorithm

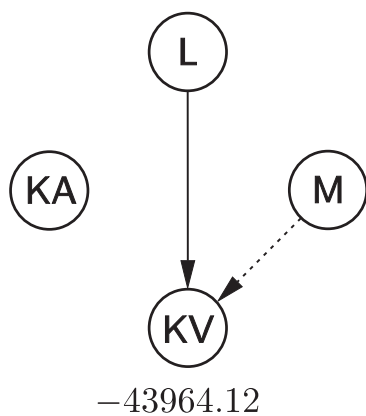

Step 5 – Insert **M** temporarily.

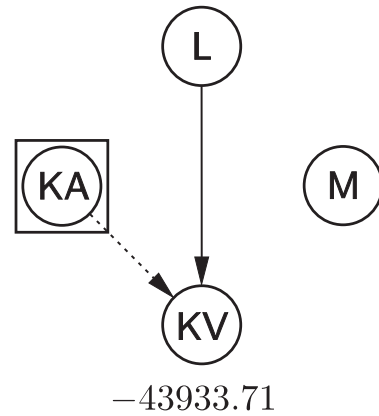

Step 6 – **KA** is added as second parent node of **KV**.

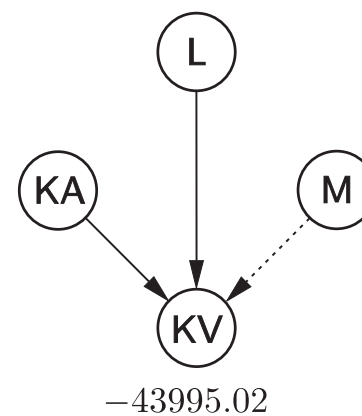

Step 7 – **M** does not increase the quality of the network if inserts as third parent node.

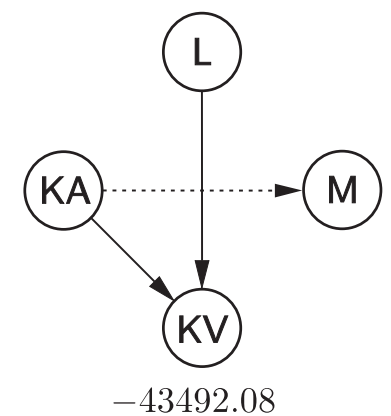

Step 8 – Insert **KA** temporarily.

Demo of K2 Algorithm

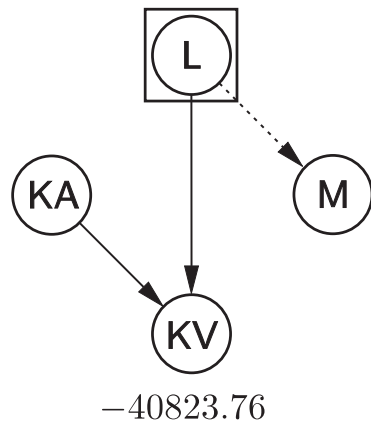

Step 9 – Node **L** becomes parent node of **M**.

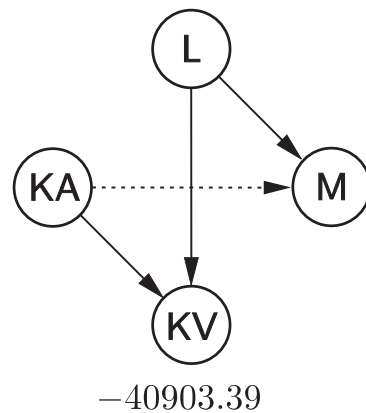

Step 10 – Adding **KA** does not increase overall network quality.

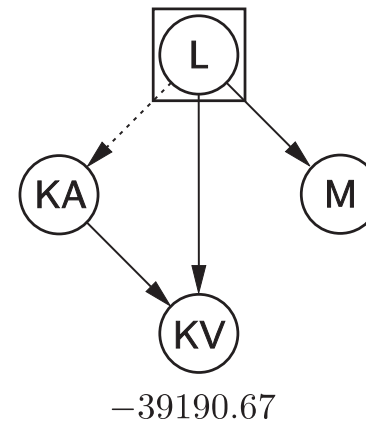

Step 11 – Node **L** becomes parent node of **KA**.

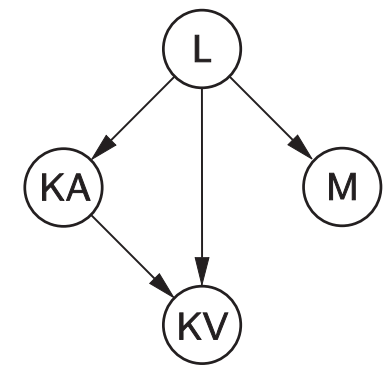

Result

Strength of Marginal Dependences: Drawbacks

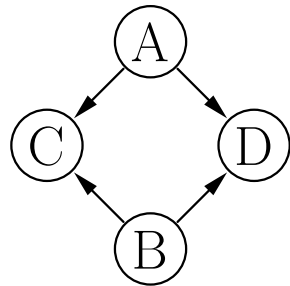

p_A	a_1	a_2
	0.5	0.5

p_B	b_1	b_2
	0.5	0.5

$p_{C AB}$	a_1b_1	a_1b_2	a_2b_1	a_2b_2
c_1	0.9	0.3	0.3	0.5
c_2	0.1	0.7	0.7	0.5

$p_{D AB}$	a_1b_1	a_1b_2	a_2b_1	a_2b_2
d_1	0.9	0.3	0.3	0.5
d_2	0.1	0.7	0.7	0.5

p_{AD}	a_1	a_2
d_1	0.3	0.2
d_2	0.2	0.3

p_{BD}	b_1	b_2
d_1	0.3	0.2
d_2	0.2	0.3

p_{CD}	c_1	c_2
d_1	0.31	0.19
d_2	0.19	0.31

Greedy parent selection can lead to suboptimal results if there is more than one path connecting two attributes.

Here: the edge $C \rightarrow D$ is selected first.

Learning the Structure of Graphical Models from Data

(A) Test whether a distribution is decomposable w.r.t. a given graph.

This is the most direct approach. It is not bound to a graphical representation, but can also be carried out w.r.t. other representations of the set of subspaces to be used to compute the (candidate) decomposition of the given distribution.

(B) Find a suitable graph by measuring the strength of dependences.

This is a heuristic, but often highly successful approach, which is based on the frequently valid assumption that in a conditional independence graph an attribute is more strongly dependent on adjacent attributes than on attributes that are not directly connected to them.

(C) Find an independence map by conditional independence tests.

This approach exploits the theorems that connect conditional independence graphs and graphs that represent decompositions. It has the advantage that a single conditional independence test, if it fails, can exclude several candidate graphs. However, wrong test results can thus have severe consequences.

Structure Learning with Conditional Independence Tests

General Idea: Exploit the theorems that connect conditional independence graphs and graphs that represent decompositions.

In other words: we want a graph describing a decomposition,
but we search for a conditional independence graph.

This approach has the advantage that a single conditional independence test, if it fails, can exclude several candidate graphs.

Assumptions:

Faithfulness: The domain under consideration can be accurately described with a graphical model (more precisely: there exists a perfect map).

Reliability of Tests: The result of all conditional independence tests coincides with the actual situation in the underlying distribution.

Other assumptions that are specific to individual algorithms.

Conditional Independence Tests: Relational

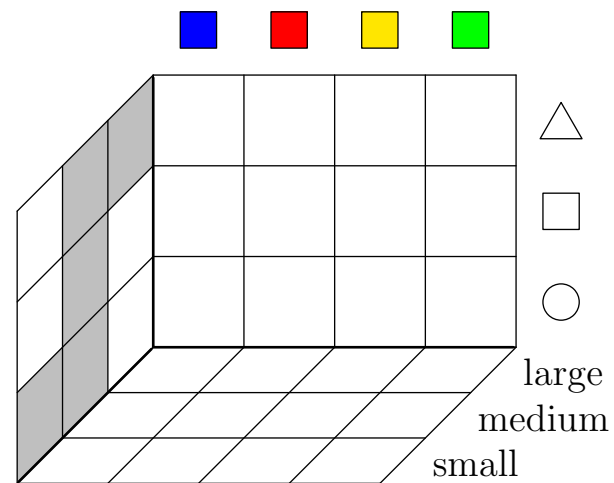
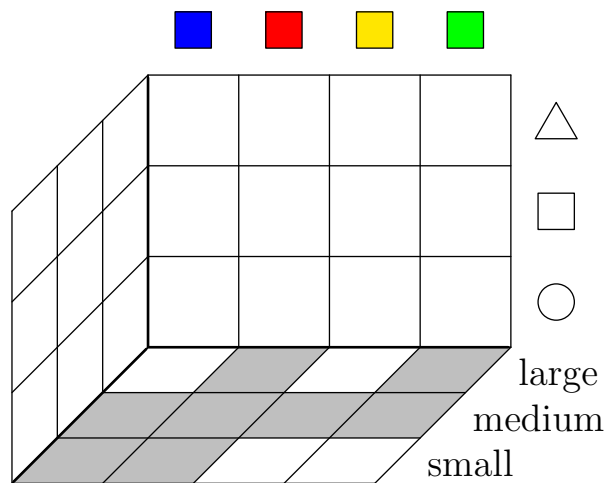
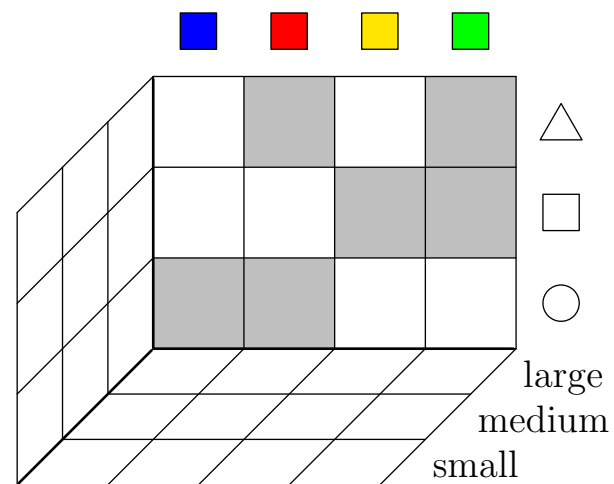
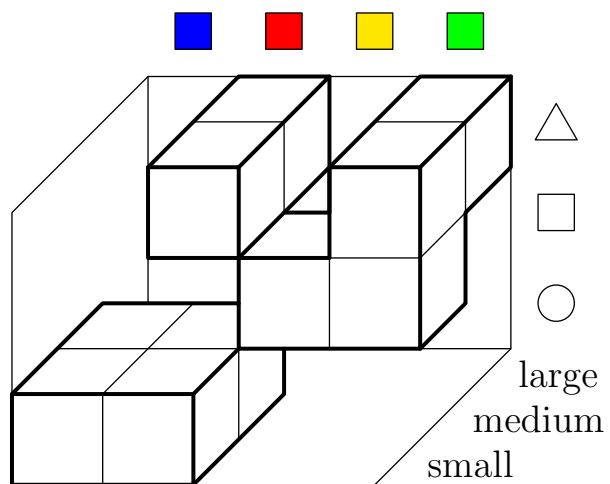

Conditional Independence Tests: Relational

The Hartley information gain can be used directly to test for (approximate) **marginal independence**.

attributes	relative number of possible value combinations	Hartley information gain
color, shape	$\frac{6}{3 \cdot 4} = \frac{1}{2} = 50\%$	$\log_2 3 + \log_2 4 - \log_2 6 = 1$
color, size	$\frac{8}{3 \cdot 4} = \frac{2}{3} \approx 67\%$	$\log_2 3 + \log_2 4 - \log_2 8 \approx 0.58$
shape, size	$\frac{5}{3 \cdot 3} = \frac{5}{9} \approx 56\%$	$\log_2 3 + \log_2 3 - \log_2 5 \approx 0.85$

In order to test for (approximate) **conditional independence**:

- Compute the Hartley information gain for each possible instantiation of the conditioning attributes.
- Aggregate the result over all possible instantiations, for instance, by simply averaging them.

Conditional Independence Tests: Simple Example

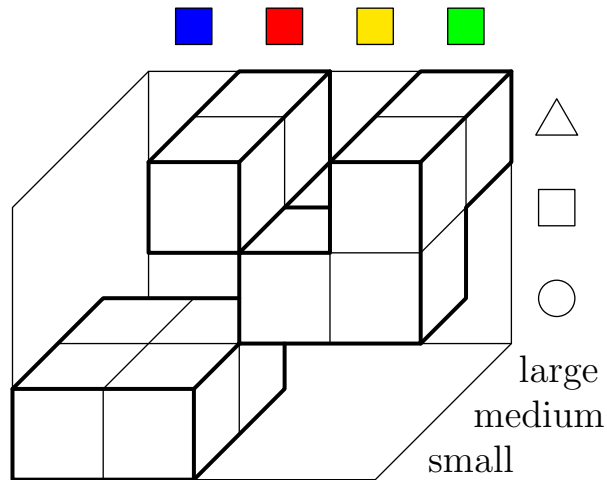

color	Hartley information gain
■	$\log_2 1 + \log_2 2 - \log_2 2 = 0$
■	$\log_2 2 + \log_2 3 - \log_2 4 \approx 0.58$
■	$\log_2 1 + \log_2 1 - \log_2 1 = 0$
■	$\log_2 2 + \log_2 2 - \log_2 2 = 1$
	average: ≈ 0.40

shape	Hartley information gain
△	$\log_2 2 + \log_2 2 - \log_2 4 = 0$
□	$\log_2 2 + \log_2 1 - \log_2 2 = 0$
○	$\log_2 2 + \log_2 2 - \log_2 4 = 0$
	average: $= 0$

size	Hartley information gain
large	$\log_2 2 + \log_2 1 - \log_2 2 = 0$
medium	$\log_2 4 + \log_2 3 - \log_2 6 = 1$
small	$\log_2 2 + \log_2 1 - \log_2 2 = 0$
	average: ≈ 0.33

Conditional Independence Tests: Simple Example

The Shannon information gain can be used directly to test for (approximate) **marginal independence**.

Conditional independence tests may be carried out by summing the information gain for all instantiations of the conditioning variables:

$$I_{\text{gain}}(A, B \mid C) = \sum_{c \in \text{dom}(C)} P(c) \sum_{a \in \text{dom}(A)} \sum_{b \in \text{dom}(B)} P(a, b \mid c) \log_2 \frac{P(a, b \mid c)}{P(a \mid c) P(b \mid c)},$$

where $P(c)$ is an abbreviation of $P(C = c)$ etc.

Since $I_{\text{gain}}(\text{color}, \text{size} \mid \text{shape}) = 0$ indicates the only conditional independence, we get the following learning result:



Conditional Independence Tests: General Algorithm

Algorithm: (conditional independence graph construction)

1. For each pair of attributes A and B , search for a set $S_{AB} \subseteq U \setminus \{A, B\}$ such that $A \perp\!\!\!\perp B \mid S_{AB}$ holds in \hat{P} , i.e., A and B are independent in \hat{P} conditioned on S_{AB} . If there is no such S_{AB} , connect the attributes by an undirected edge.
2. For each pair of non-adjacent variables A and B with a common neighbour C (i.e., C is adjacent to A as well as to B), check whether $C \in S_{AB}$.
 - If it is, continue.
 - If it is not, add arrow heads pointing to C , i.e., $A \rightarrow C \leftarrow B$.
3. Recursively direct all undirected edges according to the rules:
 - If for two adjacent variables A and B there is a strictly directed path from A to B not including $A \rightarrow B$, then direct the edge towards B .
 - If there are three variables A , B , and C with A and B not adjacent, $B - C$, and $A \rightarrow C$, then direct the edge $C \rightarrow B$.

Conditional Independence Tests: Simple Example

Suppose that the following conditional independence statements hold:

$$\begin{array}{ll} A \perp\!\!\!\perp_{\hat{P}} B \mid \emptyset & B \perp\!\!\!\perp_{\hat{P}} A \mid \emptyset \\ A \perp\!\!\!\perp_{\hat{P}} D \mid C & D \perp\!\!\!\perp_{\hat{P}} A \mid C \\ B \perp\!\!\!\perp_{\hat{P}} D \mid C & D \perp\!\!\!\perp_{\hat{P}} B \mid C \end{array}$$

All other possible conditional independence statements that can be formed with the attributes A , B , C , and D (with single attributes on the left) do not hold.

Step 1: Since there is no set rendering A and C , B and C and C and D independent, the edges $A - C$, $B - C$, and $C - D$ are inserted.

Step 2: Since C is a common neighbor of A and B and we have $A \perp\!\!\!\perp_{\hat{P}} B \mid \emptyset$, but $A \not\perp\!\!\!\perp_{\hat{P}} B \mid C$, the first two edges must be directed $A \rightarrow C \leftarrow B$.

Step 3: Since A and D are not adjacent, $C - D$ and $A \rightarrow C$, the edge $C - D$ must be directed $C \rightarrow D$.

(Otherwise step 2 would have already fixed the orientation $C \leftarrow D$.)

Conditional Independence Tests: Drawbacks

The conditional independence graph construction algorithm presupposes that there is a **perfect map**. If there is no perfect map, the result may be invalid.

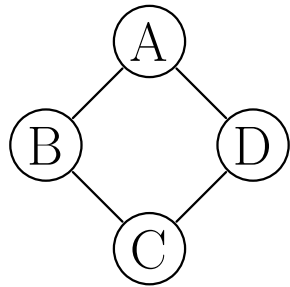

p_{ABCD}	$A = a_1$		$A = a_2$		
	$B = b_1$	$B = b_2$	$B = b_1$	$B = b_2$	
$C = c_1$	$D = d_1$	$1/47$	$1/47$	$1/47$	$2/47$
	$D = d_2$	$1/47$	$1/47$	$2/47$	$4/47$
$C = c_2$	$D = d_1$	$1/47$	$2/47$	$1/47$	$4/47$
	$D = d_2$	$2/47$	$4/47$	$4/47$	$16/47$

Independence tests of high order, i. e., with a large number of conditions, may be necessary.

There are approaches to mitigate these drawbacks.

(For example, the order is restricted and all tests of higher order are assumed to fail, if all tests of lower order failed.)

The Cheng–Bell–Liu Algorithm

Drafting: Build a so-called Chow–Liu tree as an initial graphical model.

- Evaluate all attribute pairs (candidate edges) with information gain.
- Discard edges with evaluation below independence threshold (~ 0.1 bits).
- Build optimum (maximum) weight spanning tree.

Thickening: Add necessary edges.

- Traverse remaining candidate edges in the order of decreasing evaluation.
- Test for conditional independence in order to determine whether an edge is needed in the graphical model.
- Use local Markov property to select a condition set: an attribute is conditionally independent of all non-descendants given its parents.
- Since the graph is undirected in this step, the set of adjacent nodes is reduced iteratively and greedily in order to remove possible children.

The Cheng–Bell–Liu Algorithm (continued)

Thinning: Remove superfluous edges.

- In the thickening phase a conditional independence test may have failed, because the graph was still too sparse.
- Traverse all edges that have been added to the current graphical model and test for conditional independence.
- Remove unnecessary edges.
(two phases/approaches: heuristic test/strict test)

Orienting: Direct the edges of the graphical model.

- Identify the v -structures (converging directed edges).
(Markov equivalence: same skeleton and same set of v -structures.)
- Traverse all pairs of attributes with common neighbors and check which common neighbors are in the (maximally) reduced set of conditions.
- Direct remaining edges by extending chains and avoiding cycles.

Learning Undirected Graphical Models Directly

Drafting: Build a Chow–Liu tree as an initial graphical model

- Evaluate all attribute pairs (candidate edges) with specificity gain.
- Discard edges with evaluation below independence threshold (~ 0.015).
- Build optimum (maximum) weight spanning tree.

Thickening: Add necessary edges.

- Traverse remaining candidate edges in the order of decreasing evaluation.
- Test for conditional independence in order to determine whether an edge is needed in the graphical model.
- Use local Markov property to select a condition set: an attribute is conditionally independent of any non-neighbor given its neighbors.
- Since the graphical model to be learned is undirected, *no (iterative) reduction of the condition set is needed* (decisive difference to Cheng–Bell–Liu Algorithm).

Learning Undirected Graphical Models Directly

Moralizing: Take care of possible v -structures.

- If one assumes a perfect undirected map, this step is unnecessary. However, v -structures are too common and cannot be represented without loss in an undirected graphical model.
- Possible v -structures can be taken care of by connecting the parents.
- Traverse all edges with an evaluation below the independence threshold that have a common neighbor in the graph.
- Add edge if conditional independence given the neighbors does not hold.

Thinning: Remove superfluous edges.

- In the thickening phase a conditional independence test may have failed, because the graph was still too sparse.
- Traverse all edges that have been added to the current graphical model and test for conditional independence.

Example: Danish Jersey Cattle

A fraction of the database of sample cases:

```
y y f1 v2 f1 v2 f1 v2 f1 v2 v2 v2 v2v2 n y n y 0 6 0 6
y y f1 v2 ** ** f1 v2 ** ** ** ** f1v2 y y n y 7 6 0 7
y y f1 v2 f1 f1 f1 v2 f1 f1 f1 f1 f1f1 y y n n 7 7 0 0
y y f1 v2 f1 f1 f1 v2 f1 f1 f1 f1 f1f1 y y n n 7 7 0 0
y y f1 v2 f1 v1 f1 v2 f1 v1 v2 f1 f1v2 y y n y 7 7 0 7
y y f1 f1 ** ** f1 f1 ** ** f1 f1 f1f1 y y n n 6 6 0 0
y y f1 v1 ** ** f1 v1 ** ** v1 v2 v1v2 n y y y 0 5 4 5
y y f1 v2 f1 v1 f1 v2 f1 v1 f1 v1 f1v1 y y y y 7 7 6 7
      ⋮                               ⋮
```

21 attributes

500 real world sample cases

A lot of missing values (indicated by **)

Danish Jersey Cattle Blood Type Determination

network	edges	params.	train	test
indep.	0	59	-19921.2	-20087.2
orig.	22	219	-11391.0	-11506.1

Optimum Weight Spanning Tree Construction

measure	edges	params.	train	test
I_{gain}	20.0	285.9	-12122.6	-12339.6
χ^2	20.0	282.9	-12122.6	-12336.2

Greedy Parent Selection w.r.t. a Topological Order

measure	edges	add.	miss.	params.	train	test
I_{gain}	35.0	17.1	4.1	1342.2	-11229.3	-11817.6
χ^2	35.0	17.3	4.3	1300.8	-11234.9	-11805.2
K2	23.3	1.4	0.1	229.9	-11385.4	-11511.5
$L_{red}^{(rel)}$	22.5	0.6	0.1	219.9	-11389.5	-11508.2

Probabilistic Graphical Models: An Example

Danish Jersey Cattle Blood Type Determination

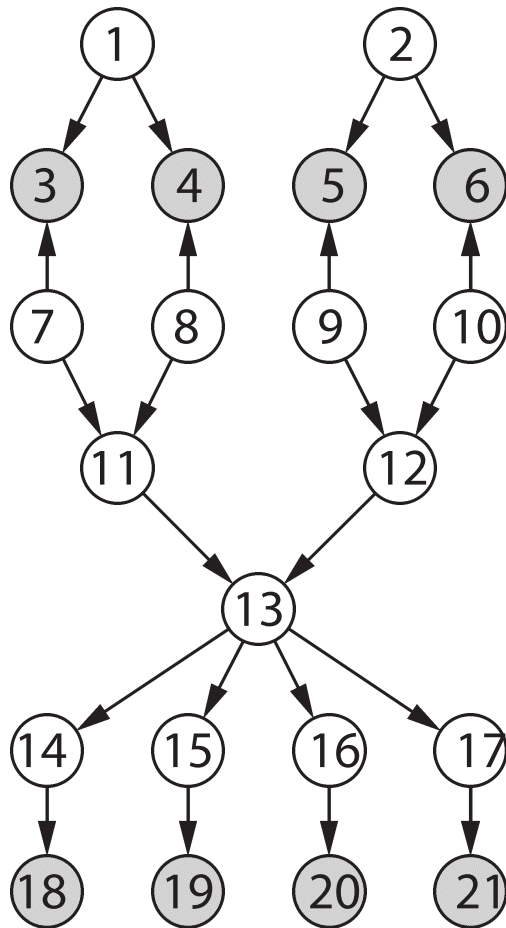

- 21 attributes:
- | | |
|--------------------------|-------------------------|
| 1 – dam correct? | 11 – offspring ph.gr. 1 |
| 2 – sire correct? | 12 – offspring ph.gr. 2 |
| 3 – stated dam ph.gr. 1 | 13 – offspring genotype |
| 4 – stated dam ph.gr. 2 | 14 – factor 40 |
| 5 – stated sire ph.gr. 1 | 15 – factor 41 |
| 6 – stated sire ph.gr. 2 | 16 – factor 42 |
| 7 – truedamph.gr. 1 | 17 – factor 43 |
| 8 – truedamph.gr. 2 | 18 – lysis40 |
| 9 – true sire ph.gr. 1 | 19 – lysis41 |
| 10 – true sire ph.gr. 2 | 20 – lysis 42 |
| | 21 – lysis 43 |

The grey nodes correspond to observable attributes.

Example: Data Mining (DaimlerChrysler AG)

Improving the Product Quality by Detecting Weaknesses

- Learn decision trees or inference network for vehicle properties and failures.
- Look for suspicious conditional failure rates.
- Find causes of these suspicious rates.
- Optimize design of vehicle.

Improve the Error Diagnosis in Service Garages

- Learn a decision tree or inference network for vehicle properties and failures.
- Record new faults.
- Test for most probable errors.

A Simple Approach to Fault Analysis

Check subnets consisting of an attribute and its parent attributes.

Select subnets with highest deviation from independent distribution.

Vehicle Properties

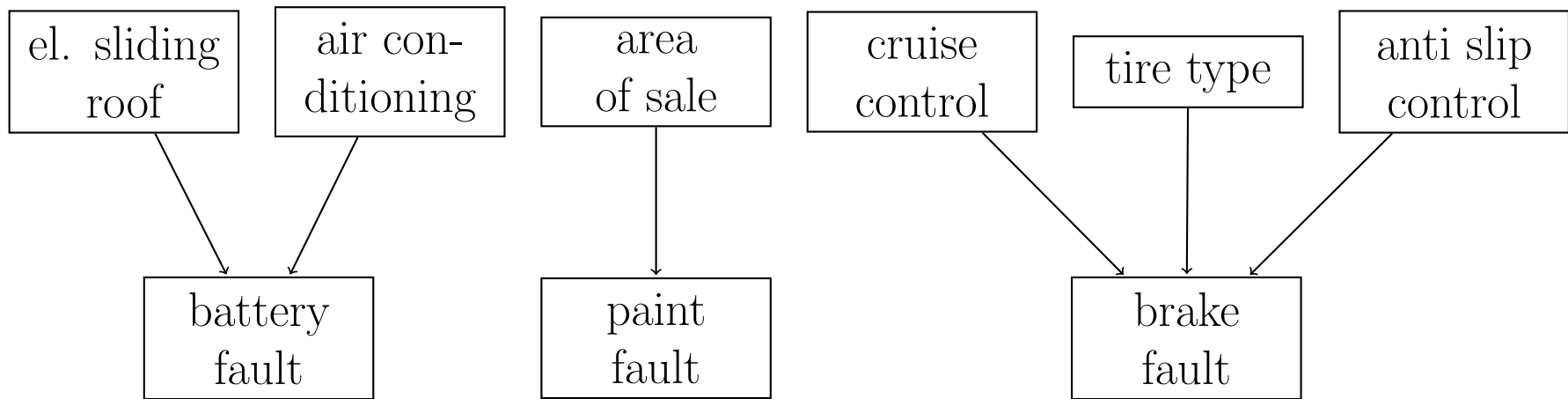

Fault Data

A Simple Approach to Fault Analysis

Influence of special equipment on battery faults:

(fictitious) frequency of battery faults		airconditioning	
		with	without
electrical sliding roof	with	8 %	3 %
	without	3 %	2 %

- Significant deviation from independent distribution.
- Hints to possible causes and improvements.
- Here: Larger batter may be required, if an air conditioning system and an electrical sliding roof are built in.